

SFS-EUL0410.0L

4 Head 10 Litres (EU)

Build to Weigh- Engineered to Last

SINGLE VIBRATOR

High-Precision Vibratory Feeding

Controlled vibration delivers a smooth, consistent flow of material for highly accurate weighing.

Dynamic Feed Rate Adjustment

SmartFill auto adjusts vibration intensity on real time load cell feedback to optimize speed and accuracy.

Multi-Stage Filling

Fast bulk feed transitions into fine and dribble feed for exact target weight achievement with minimal product giveaway.

HMI Touchscreen Interface

User-friendly, multilingual interface for recipe management, real-time monitoring, and system control. Supports Various Industry 4.0 protocols for smart factory ecosystems.

Material Flexibility

Capable of handling a wide variety of products like freeflowing granules, powders, small parts, and fragile items.

Low Maintenance, Long Lifespan

Solid-state vibratory feeders with minimal moving parts, designed for extended service intervals and reduced downtime.

Tool-free disassembly

Enabling quick and safe removal of all contact parts without any tools. Designed for daily wash-downs, it ensures fast cleaning, minimizes downtime, and meets the highest hygiene standards.

Protective Enclosures

Prevent contamination from airborne foreign particles. Engineered for food-safe environments, it ensures product purity and compliance with hygiene standards.



Bucket Capacity	10.0 liters
Feeding Hopper volume	92 liters
Weighing Range*	1000-5000 grams
Accuracy*	+/- 5~10 grams
Production Output* (Speed)	18-20 bags / minute
Operating Panel	Touchscreen HMI 7 Inches
Power Supply	AC 230V +/- 10%, 50/60 Hz
No of Preset Programs	100
Control System	Embedded
Material Of Construction***	All contact parts SS-304. Body Parts MS Powder coated
Machine Dimensions (L x W x H)	1062 x 950 x 1316 mm
Machine Weight**	Approx 145 Kgs
Optional Accessories	Customized Structure, Funnel, Elevator, Belt Sealer
Optional Models	SFS-EUL0210.0L SFS-EUL045.0L SFS-EUL025.0L

*Depends on product shape, bulk density, target weight & feeding conditions etc.

**The machine weight varies depending upon the options selected

***Complete SS-304 and SS-316 are available on request

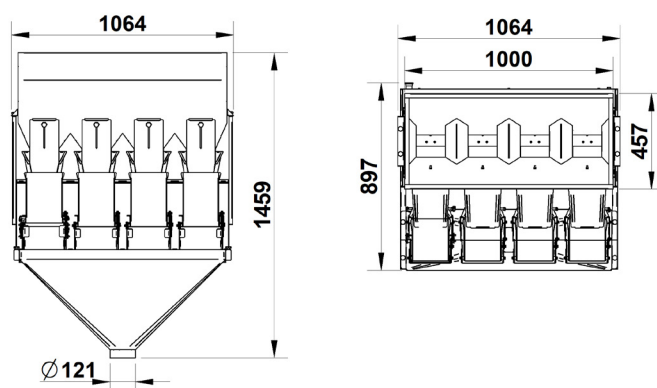

TECHNICAL INFORMATION IS BASED UPON INFORMATION AVAILABLE AS OF MAY-2025. CONFIRMATION IS PROVIDED BY SALES INQUIRY. PHOTOGRAPHS AND APPLICATION SHOTS MAY NOT BE EXACT REPRESENTATION

