

SFS-CNL047.0L

4 Head 7 Litres (CN)

Build to Weigh- Engineered to Last SINGLE VIBRATOR



High-Precision Vibratory Feeding

Controlled vibration delivers a smooth, consistent flow of material for highly accurate weighing.

Dynamic Feed Rate Adjustment

SmartFill auto adjusts vibration intensity on real time load cell feedback to optimize speed and accuracy.

Multi-Stage Filling

Fast bulk feed transitions into fine and dribble feed for exact target weight achievement with minimal product giveaway.

HMI Touchscreen Interface

User-friendly, multilingual interface for recipe management, real-time monitoring, and system control. Supports Various Industry 4.0 protocols for smart factory ecosystems.

Material Flexibility

Capable of handling a wide variety of products like freeflowing granules, powders, small parts, and fragile items.

Low Maintenance, Long Lifespan

Solid-state vibratory feeders with minimal moving parts, designed for extended service intervals and reduced downtime.

Bucket Capacity	7.0 liters
Feeding Hopper volume	155 liters
Weighing Range*	1000-5000 grams
Accuracy*	+/- 5~10 grams
Production Output* (Speed)	16-18 bags / minute
Operating Panel	Touchscreen HMI 7 Inches
Power Supply	AC 230V +/- 10%, 50/60 Hz
No of Preset Programs	100
Control System	Embedded
Material Of Construction***	All contact parts SS-304. Body Parts MS Powder coated
Machine Dimensions (L x W x H)	1064 x 897 x 1271 mm
Machine Weight**	Approx 141 Kgs
Optional Accessories	Customized Structure, Funnel, Elevator, Belt Sealer
Optional Models	SFS-CNL027.0L SFS-CNL0410.0L SFS-CNL0210.0L

*Depends on product shape, bulk density, target weight & feeding conditions etc.

**The machine weight varies depending upon the options selected

***Complete SS-304 and SS-316 are available on request

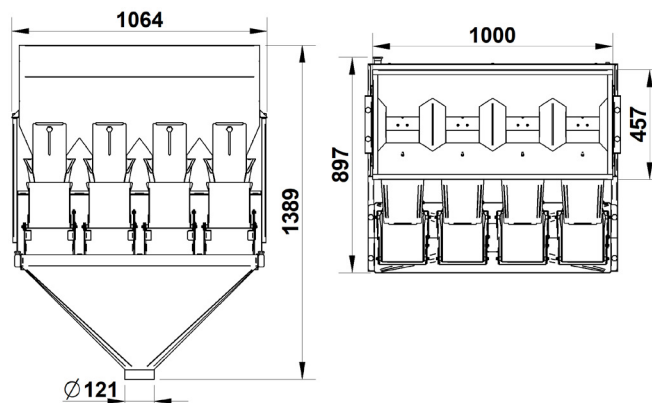

TECHNICAL INFORMATION IS BASED UPON INFORMATION AVAILABLE AS OF MAY-2025. CONFIRMATION IS PROVIDED BY SALES INQUIRY. PHOTOGRAPHS AND APPLICATION SHOTS MAY NOT BE EXACT REPRESENTATION

